

Material :

- (a) Housing : PA66(UL94V-0)
- (b) Pin Header : Brass , Tin Plated

Electrical :

- | | | |
|--|------|------|
| | UL | IEC |
| 1.Rated Voltage : | 300V | 320V |
| 2.Rated Current : | 15A | 20A |
| 3.Withstanding Voltage : AC1600V/1Min. | | |
| 4.Operating Temperature : -40°C~+105°C | | |
| 5. RoHS Compliance | | |
| 6.Safety Approval : | | |
| 7.Undimensioned Tolerances: | | |

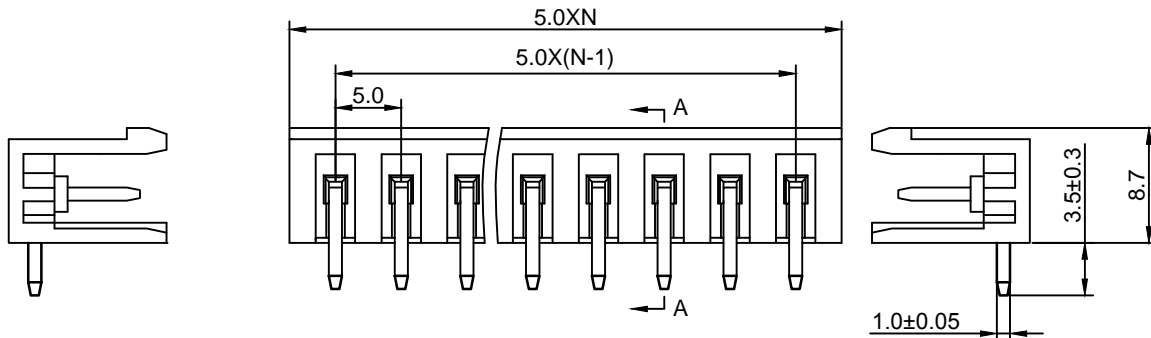

Pitch Range In mm			Nominal Dimension Range In mm					—	∩	∇
≤6	6 ~ 10	10 ~ 24	≤30	30 ~ 60	60 ~ 100	100 ~ 150	>150	0.05/10		
±0.10	±0.15	±0.25	±0.20	±0.30	±0.50	±0.70	±1.00	±0.1°		

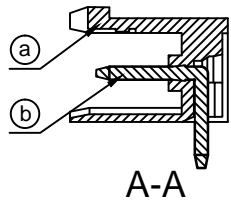
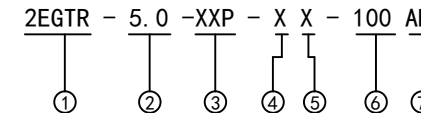

- ① Series NO.
- ② Pitch
- ③ Poles
02 02Contacts
03 03Contacts
...
24 24Contacts
- ④ 1 Single Pitch
2 Double Pitch
- ⑤ Color: 1 Grey
2 Blue
3 Black
4 Green(Standard For AH)
5 Orange
6 Red
7 Transparent
8 Yellow
9 White
- ⑥ Customer Request: 100--Standard
- ⑦ AH--Standard(PA66)

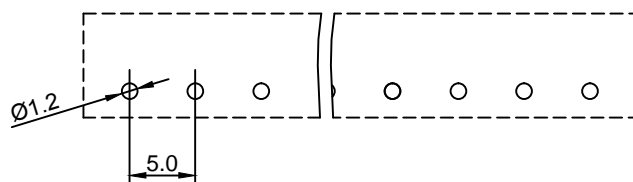

DETACHED LISTS	Grolten 宁波冠泰电子有限公司 NINGBO GOLTEN ELECTRONICS CO., LTD.	
	APPD: MA_4/11/16'	PART NO. 2EGTR-5.0-XXP-XX-100AH
	CHKD: Yu_4/10/16'	
	DRFT: Chen_4/9/16'	
 THIRD ANGLE PROJECTION	DRAWING NO.	REV 1
	DO NOT SCALE DRAWING	SHEET 1/1
	SCALE 1/1	



Material :

- (a) Housing : PA66(UL94V-0)
- (b) Pin Header : Brass , Tin Plated

Electrical :

- | | | |
|---|------|------|
| | UL | IEC |
| 1. Rated Voltage : | 300V | 320V |
| 2. Rated Current : | 15A | 20A |
| 3. Withstanding Voltage : AC1600V/1Min. | | |
| 4. Operating Temperature : -40 °C~+105 °C | | |
| 5. RoHS Compliance | | |
| 6. Safety Approval : | | |
| 7. Undimensioned Tolerances: | | |

Pitch Range In mm			Nominal Dimension Range In mm					—	∩	∇
≤6	6 ~ 10	10 ~ 24	≤30	30 ~ 60	60 ~ 100	100 ~ 150	>150	0.05/10		
±0.10	±0.15	±0.25	±0.20	±0.30	±0.50	±0.70	±1.00	±0.1°		

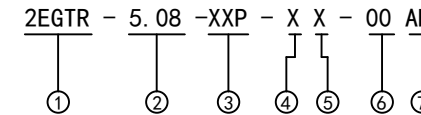
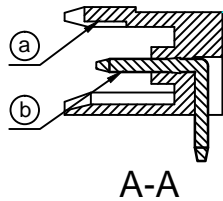
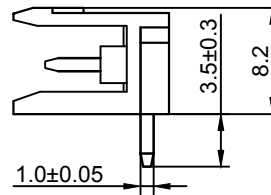
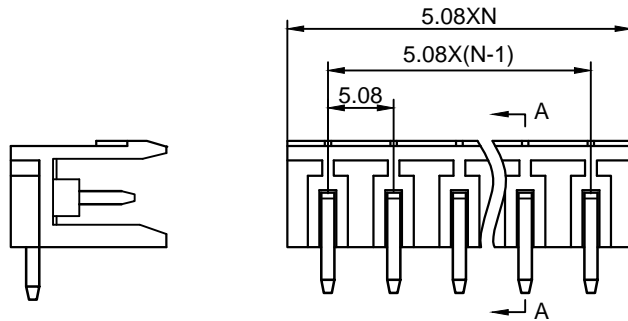

- ① Series NO.
- ② Pitch
- ③ Poles
02 02Contacts
03 03Contacts
...
24 24Contacts
- ④ 1 Single Pitch
2 Double Pitch
- ⑤ Color: 1 Grey
2 Blue
3 Black
4 Green(Standard For AH)
5 Orange
6 Red
7 Transparent
8 Yellow
9 White
- ⑥ Customer Request: 00--Standard
- ⑦ AH--Standard(PA66)

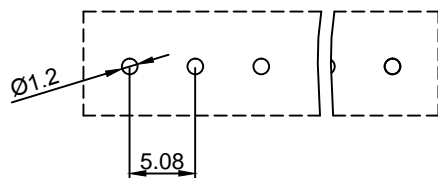

DETACHED LISTS	Golten 宁波冠泰电子有限公司 NINGBO GOLTEN ELECTRONICS CO., LTD.			
	APPD: MA_4/11/16'	PART NO. 2EGTR-5.08-XXP-XX-00AH		
	CHKD: Yu_4/10/16'			
	DRFT: Chen_4/9/16'			
 THIRD ANGLE PROJECTION	DRAWING NO.		REV	1
	DO NOT SCALE DRAWING		SHEET	1/1
	MM (INCH)	SCALE	1/1	



Material :

- (a) Housing : PA66(UL94V-0)
- (b) Pin Header : Brass , Tin Plated

Electrical :

- | | | |
|--|------|------|
| | UL | IEC |
| 1.Rated Voltage : | 300V | 400V |
| 2.Rated Current : | 15A | 20A |
| 3.Withstanding Voltage : AC1600V/1Min. | | |
| 4.Operating Temperature : -40°C~+105°C | | |
| 5. RoHS Compliance | | |
| 6.Safety Approval : | | |
| 7.Undimensioned Tolerances: | | |

Pitch Range In mm		Nominal Dimension Range In mm						—	∩	∇
≤6	6 ~ 10	10 ~ 24	≤30	30 ~ 60	60 ~ 100	100 ~ 150	>150	0.05/10		
±0.10	±0.15	±0.25	±0.20	±0.30	±0.50	±0.70	±1.00	±0.1°		

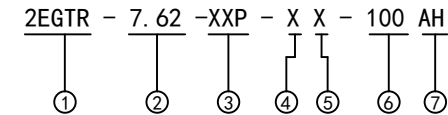
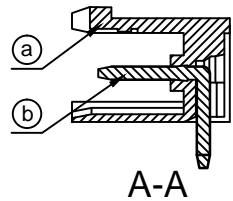
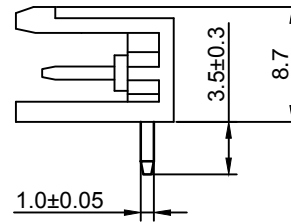
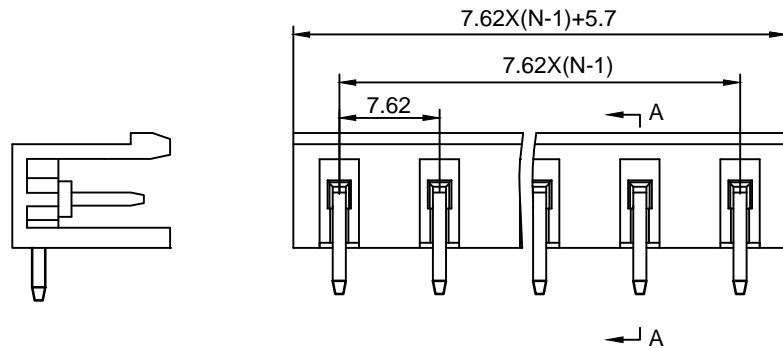

- ① Series NO.
- ② Pitch
- ③ Poles
02 02Contacts
03 03Contacts
...
24 24Contacts
- ④ 1 Single Pitch
2 Double Pitch
- ⑤ Color: 1 Grey
2 Blue
3 Black
4 Green(Standard For AH)
5 Orange
6 Red
7 Transparent
8 Yellow
9 White
- ⑥ Customer Request: 100--Standard
- ⑦ AH--Standard(PA66)

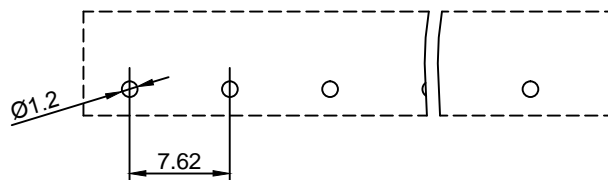

DETACHED LISTS	Golten 宁波冠泰电子有限公司 NINGBO GOLTEN ELECTRONICS CO., LTD.	
	APPD: MA_4/11/16'	PART NO. 2EGTR-7.62-XXP-XX-100AH
	CHKD: Yu_4/10/16'	
	DRFT: Chen_4/9/16'	
 THIRD ANGLE PROJECTION	DRAWING NO.	REV 1
	DO NOT SCALE DRAWING	SHEET 1/1
	SCALE 1/1	